

## PL-CORE-G7 2000-840 L15 H1

PrevaLED Core G7 L15 H1 | Spot-, Down- and Wallmount Light Engines and Modules



### A termék jellemzői

- Complete portfolio with varying luminous flux, color temperature, color rendering
- Available with color temperature: 2,700 K, 3,000 K, 3,500 K or 4,000 K
- OEM Programmable with 1mA resolution to perfectly match LED load and maximize performance

### A termék előnyei

- High driver flexibility allows cost-effective and intelligent systems
- 5 year guarantee

### Alkalmazási területek

- Spotlighting in shops and retail
- Down- and wall lighting in offices, corridors, meeting rooms, workplaces
- Decorative and functional lighting in hospitality, hotels, restaurants
- Functional lighting in public and commercial buildings



## Termék adatlap

### Műszaki adatok

#### Elektromos adatok

Névleges feszültség	34.1 V
Névleges áram	0.349 A
Áram típusa	DC
On-mode power	11.7 W
Energy consumption in on-mode [GMS]	11.7 kWh/1000h

#### Fotometriai adatok

Luminous efficacy	168 lm/W
Színvisszaadási index	≥80
Fényszín (megnevezés)	Semleges fehér
Correlated color temperature CCT [GMS]	4000 K
Peak luminous intensity [GMS]	680
Colour consistency (McAdam ellipszes) [GMS]	3
Useful luminous flux ( $\Phi_{use}$ ) [GMS]	1531 lm <sup>1)</sup>

<sup>1)</sup> 120°

#### Fénytechnikai adatok

Gyújtási idő	0.0 s
Bemelegedési idő	0.00 s

#### Méretetek és súly

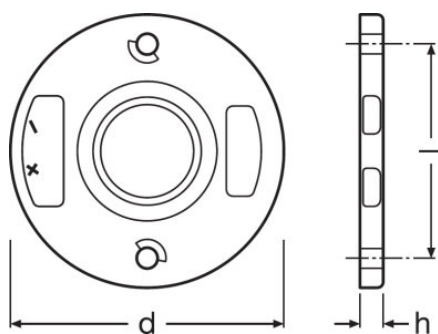

Termék súlya	6.00 g
Height [GMS]	3 mm
Length [GMS]	44 mm
Width [GMS]	44 mm
Átmérő	44.0 mm

## Termék adatlap

### Hőmérséklet és működési feltételek

Működési hőmérséklet IEC 62717 szerint	65 °C
Max. hőmérséklet a tc mérőponton	100 °C
Környezeti hőmérséklet tartomány	-20...+50 °C
Hőmérséklet-tartomány tároláskor	-20...60 °C

### Élettartam

Kapcsolási ciklusok száma	100000
Lumen maintenance factor LMF [GMS]	96
L70B50 lifetime [GMS]	60000 h

### További termékadatok

Product remark	Modules perfectly matched to OSRAM OPTOTRONIC LED drivers (see relevant table)/For current photometric data and important safety, installation and application information (see <a href="http://www.osram.com/led-systems">www.osram.com/led-systems</a> )/All the technical parameters apply to the entire module. In view of the complex manufacturing process for light emitting diodes, the typical values given above for the technical LED parameters are merely statistical values that do not necessarily correspond to the actual technical parameters of an individual product; individual products may vary from the typical values/Tolerance for optical and electrical data: +/-10%
Lighting technology used [GMS]	LED

### Tanúsítványok és szabványok

Szabványok	CE/ENEC
Védettség típusa	IP20
Energy efficiency class [GMS]	D

### Logisztikai adatok

Commodity code	854141000000
----------------	--------------







### Environmental information

<b>Information according Art. 33 of EU Regulation (EC) 1907/2006 (REACH)</b>	
Date of Declaration	18-04-2022
Primary Article Identifier	4052899534360
Candidate List Substance 1	No declarable substances contained
Declaration No. in SCIP database	No declarable substances contained



664174\_5 Year OSRAM  
Guarantee (LED)

### Download Data

File	
	Addon Technical Information PrevaLED Core G7 Overview
	Certificates ENEC Certificate PL CORE G7
	Declarations of conformity PL CORE G7 CE 3610978 150322
	CAD data PL CORE G7 L15 H1 IGS 150520
	CAD data PL CORE G7 L15 H1 STEP 150520
	CAD Data 2-dim PL CORE G7 L15 H1 CAD2PDF 150520
	CAD data 3-dim PL CORE G7 L15 H1 CAD3PDF 150520

### Ecodesign regulation information:

Separate control gear and light sources must be disposed of at certified disposal companies in accordance with Directive 2012/19/EU (WEEE) in the EU and with Waste Electrical and Electronic Equipment (WEEE) Regulations 2013 in the UK. For this purpose, collection points for recycling centres and take-back systems (CRSO) are available from retailers or private disposal companies, which accept separate control gear and light sources free of charge. In this way, raw materials are conserved and materials are recycled.

## Termék adatlap

---

### Logisztikai adatok

Termékkód	Termékmegnevezés	Csomagolás (darab/egység)	Méreték (hosszúság x szélesség x magasság)	Térfogat	Bruttó súly
4052899534360	PL-CORE-G7 2000-840 L15 H1	Karton 40	375 mm x 263 mm x 38 mm	3.75 dm <sup>3</sup>	807.00 g

---

The mentioned product code describes the smallest quantity unit which can be ordered. One shipping unit can contain one or more single products. When placing an order, for the quantity please enter single or multiples of a shipping unit.

---

### References / Links

For more information on the multi-level guarantee and the terms and conditions of the guarantee visit

▶ [www.osram.com/system-guarantee](http://www.osram.com/system-guarantee)

---

### Lemondás

Subject to change without notice. Errors and omission excepted. Always make sure to use the most recent release.