

HF LS LI

HF LS LI | Sensors for light management systems



A termék jellemzői

- Light and presence sensor for luminaire installation or attachment
- Presence detection via active radar sensor element
- Function indicator with two-color LED
- Motion detection range adjustable
- Mounting height: 2...13 m
- Integrated infrared remote control receiver
- Connection via polarity reversal protected 4p4c socket (RJ10)

A termék előnyei

- Individual activation/deactivation of light and presence sensor via remote control
- $V(\lambda)$ corrected light sensor element

Alkalmazási területek

- Corridor lighting control in logistic centers and factory halls
- Areas with high ceilings

Termék adatlap

Műszaki adatok

Méretetek és súly

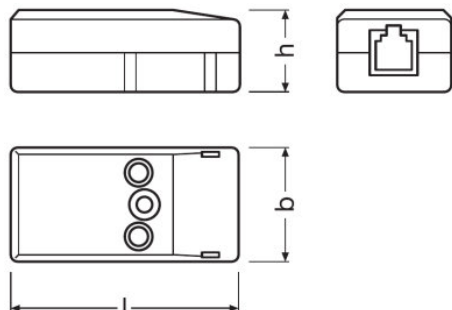

Hosszúság	56.0 mm
Szélesség	28.0 mm
Magasság	21.0 mm
Termék súlya	22.00 g

Szín és anyag

Termék színe	White
--------------	-------

Hőmérséklet és működési feltételek

Környezeti hőmérséklet tartomány	-20...+50 °C
----------------------------------	--------------

Képességek

Max. szerelési magasság	8 m
Érzékelési szög	35...80 °
Működési tartomány, fényérzékelő	20...800 lx ¹⁾
Installáció típusa	Lámpatest tartozék/Luminaire integration

¹⁾ Kb., az érzékelőn mérve

Tanúsítványok és szabványok

Védettség típusa	IP20
------------------	------

Logisztikai adatok

Commodity code	853650199000
----------------	--------------

Termék adatlap





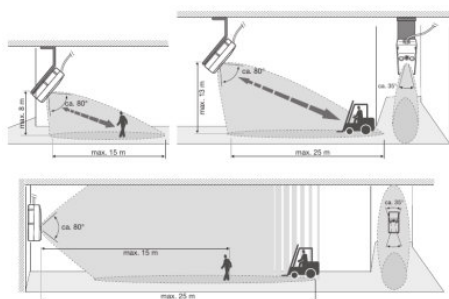





Equipment / Accessories

- Suitable for DALIeco Control unit



490632_HF LS LI detection range wall mounting angle

Download Data

File	
	User instruction HF LS LI
	Brochures DALIeco: Multi-functional light management system (EN)
	Brochures Light is the efficiency booster - LED-based industrial lighting (EN)
	Brochures Light is the efficiency booster - LED-based industrial lighting (DE)
	Declarations of conformity 505227_CE Declaration DALIeco system
	Operating instructions 473257_Operating instructions HF LS LI
	CAD data HF LS LI CAD Data IGS
	CAD data 3-dim HF LS LI CAD step
	CAD data 3-dim HF LS LI CAD Data xT
	CAD data PDF HF LS LI CAD pdf

Termék adatlap

Logisztikai adatok

Termékkód	Termékmegnevezés	Csomagolás (darab/egység)	Méreték (hosszúság x szélesség x magasság)	Térfogat	Bruttó súly
4052899921481	HF LS LI	Karton 25	180 mm x 160 mm x 70 mm	2.02 dm ³	680.00 g

The mentioned product code describes the smallest quantity unit which can be ordered. One shipping unit can contain one or more single products. When placing an order, for the quantity please enter single or multiples of a shipping unit.

Lemondás

Subject to change without notice. Errors and omission excepted. Always make sure to use the most recent release.